



FOOD
COLLECTION



SPREADS

An extensive selection of jars out of which gourmets will love sneaking spoonfuls.

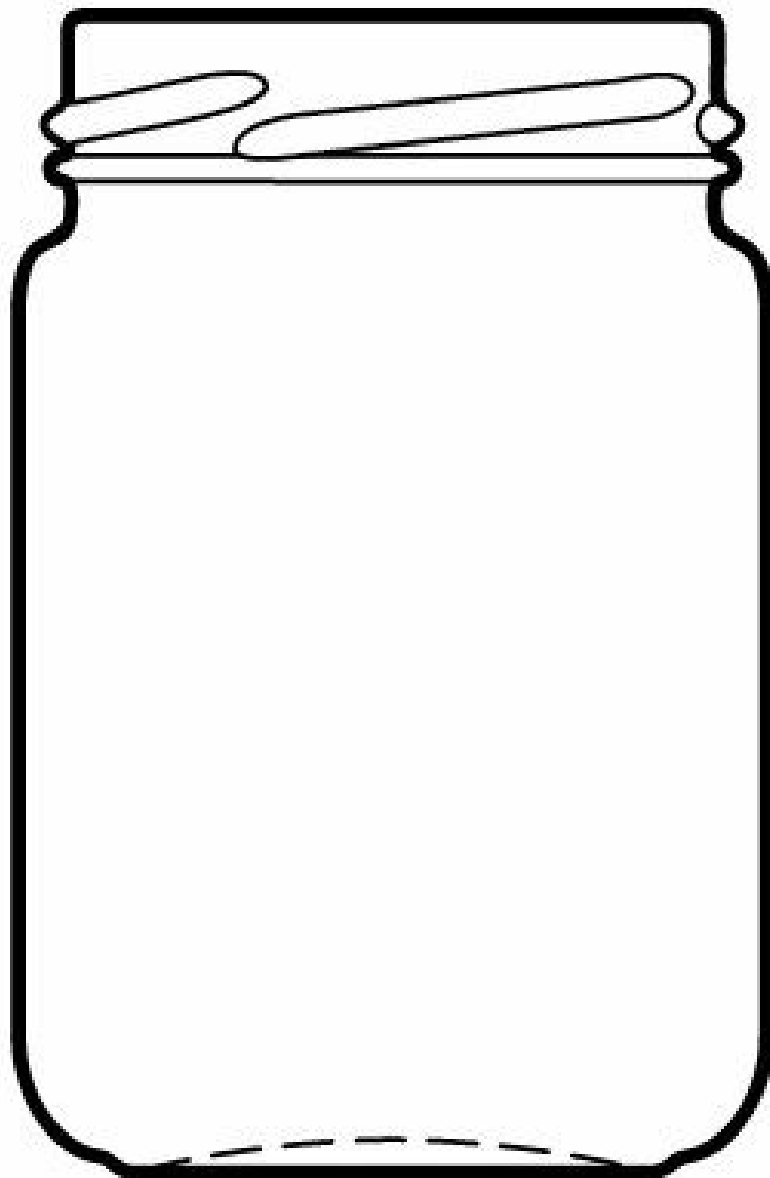

**156ML
CONSERVAS TO53**

AVAILABLE COLORS



Flint

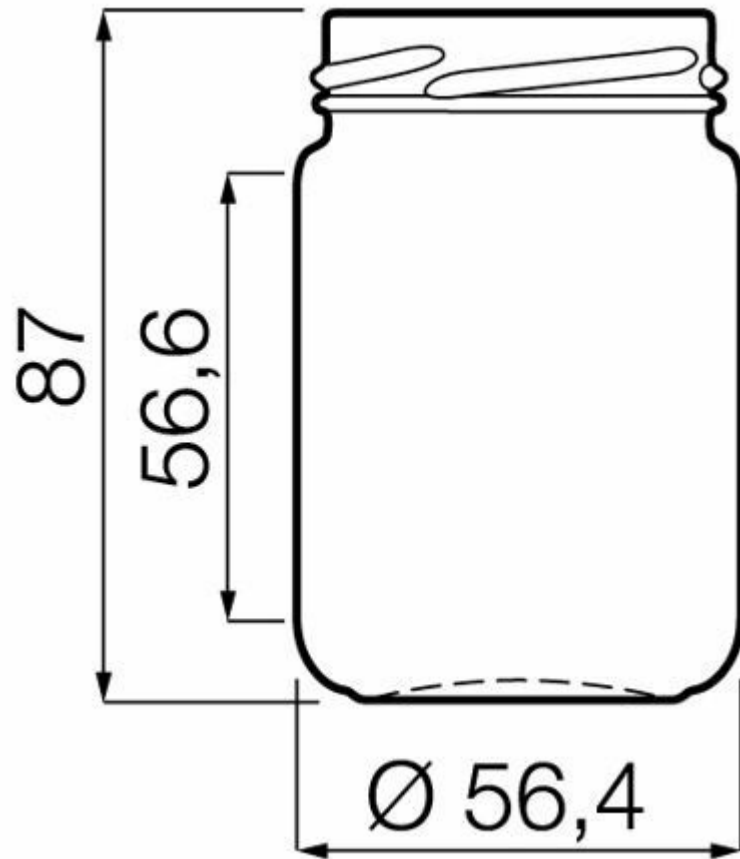

TECHNICAL SPECIFICATIONS

Product code	007015
Capacity	15.6 cl
Brimfull capacity	15.6 cl
Height	87.0 mm
Diameter	56.4 mm
Shape	Round
Finish	Wide mouth
Label protection	No
Refillable	No
Weight	110 g
Country	Spain

PACKAGING SPECIFICATIONS

Containers per pallet	4920
Layers per pallet	13
Pallet width	1000 mm
Pallet depth	1200 mm
Pallet height	1230 mm
Gross weight of pallet	579.00 kg

i Other packaging specs are available upon request.



O-I Europe - 5 February 2025

The images, specifications and other data on this page are for information purposes only. The present information can in no way be used or interpreted as a technical drawing. Specific advice should be obtained from your O-I representative with regards to the suitability of products prior to any application. The information on industry containers is updated from time to time, however O-I reserves the right to amend the specifications or to withdraw certain containers from sale without notice.

www.o-i.com

www.glass-catalog.com

© 2025, O-I Glass, Inc